

MANUAL Heavy-Duty Convection Ovens Instruction Manual

Half Size Models



**Model XAF-113:
Half Size/3 Shelves
120 Volt**



**Model XAF-133:
Half Size/4 Shelves
208-240 Volt**

Full Size Models



**Model XAF-183:
Full Size/3 Shelves
208-240 Volt**



**Model XAF-193:
Full Size/4 Shelves
208-240 Volt**

INDEX:

I. Instructions For The Installer	3
1. Data Plate	3
2. Certification	3
3. Installation - Preliminary Operations	3
3.1 – Location of Installation	3
3.2 – Feet Assembly	3
3.3 – Positioning	3
3.4 – Removing Protective Film	3
4. Installation	4
4.1 - Electrical Connection	4
4.2 - Water Connection (for XAF-113, XAF-133, XAF-183, XAF-193).....	4
II. Instructions For The User	5
1. Instruction For The Operator	5
2. Notes For Use	5
3. Control Panel	5
3.1 – Time Dial	5
3.2 – Temperature Dial	5
3.3 – Humidity Button	6
4. Door & Fans	6
5. Cleaning Oven	6
6. Turning Off In Case Of Breakdown	8
III. Cooking Principles	8
1. Cooking Modes	8
2. Cooking Variables	8
3. Use of Wire Grids & Sheet Pans	8
IV. Maintenance	8
1. Ordinary Maintenance	8
2. Special Maintenance	8
2.1 – Replacement of Door Lamp	9
2.2 – Reset The Safety Thermostat	11
V. Optional Oven Accessories	11
VI. Remove & Reattach Oven Door	12
VI. Cooking Guide	14
VII. Warranty	19

I. INSTRUCTION FOR THE INSTALLER

Congratulations! You have just purchased a new Cadco Heavy-Duty Manual Convection Oven. Let's go over some of the basics before you start using your new oven.

1. DATA PLATE

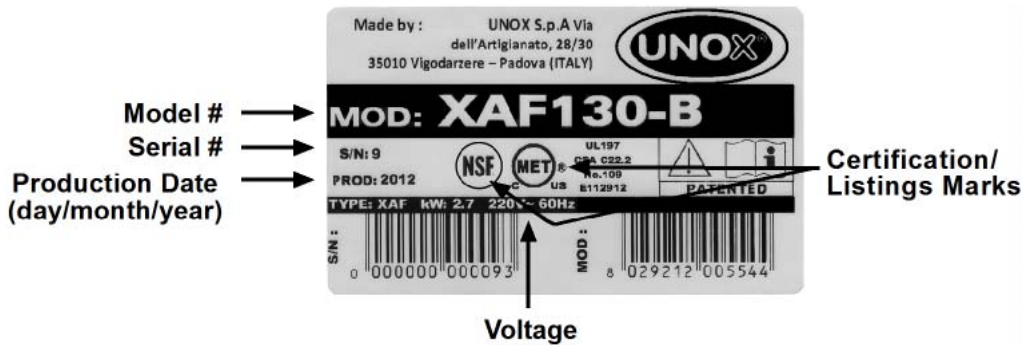

2. CERTIFICATION

2.1 The “MET” mark on our data labels and on our user manual refers to the following listings:

Certifications are listed under UNOX S.p.A., MET file #E112912, including XAF series oven models

Class Number: 2831-03 **DESCRIPTION:** HEATERS-Cooking and Liquid - Stationary Type

Class Number: 2831-83 **DESCRIPTION:** HEATERS-Cooking and Liquid-Stationary Type-
Certified to the requirements of UL 197 (for USA)
and CSA C22.2 No. 9 (for Canada)

2.2 The “NSF” mark refers to listing including XAF series oven models under UNOX SPA for NSF/ANSI STANDARD 4: Commercial Cooking, Rethermalization and Powered Hot Food Holding and Transport Equipment

3. INSTALLATION - PRELIMINARY OPERATIONS

All electrical connections and installation operations must be done by qualified personnel, and comply with all existing codes.

3.1 CHECK THE LOCATION OF INSTALLATION

Verify the overall measurements and the exact position of the electrical and water connections (where applicable) before installing the oven. Refer to the illustrations in the separate “technical data” document for your model.

3.2 FEET ASSEMBLY

You will find the feet packed inside your oven's cooking cavity. The feet **must** be used when your oven is in operation. Never use your oven without its feet properly installed. Assemble the feet as shown. (Full size models now come with tall feet that screw into place; all other models come with shorter feet that pop into place.)

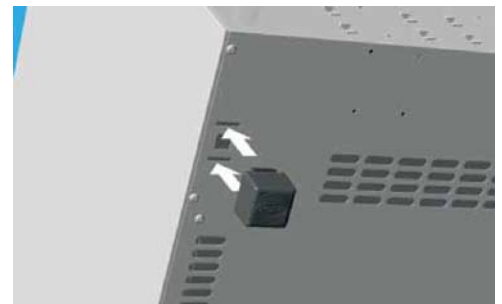

3.3 POSITIONING

Place your oven so the back and sides can be easily reached. This will make the electrical connections and any servicing points easily accessible. Your oven is not designed for built-in applications or for side by side positioning. Cadco suggests you leave a minimum distance of 4” between the back of the oven and the wall to allow for the escape of moisture. The oven must be placed upon a support, a stand, or on top of a counter made of non-combustible material. Never install the oven directly on the floor. If the oven is placed near walls, dividers, kitchen cabinets, decorated edges or drapes, they must be made of non combustibile material.

3.4 REMOVE THE PROTECTIVE FILM

Carefully remove all the protective film from the external walls of your oven. Be sure to remove any residual glue left on the outside of the oven with an appropriate solvent.

4. INSTALLATION

4.1 ELECTRICAL CONNECTION

- Connection to the electrical power source must be done according to all state and local codes. Before connecting your oven, make sure that the voltage and the amps comply with those stated on the data plate of your oven. Avoid using patch cords and multiple jacks.
- The appliance must be placed so that the connection plug to the outlet can be easily reached. When the appliance is in operation, the power supply voltage must not diverge from the value of the nominal voltage, written on the technical data plate, by more than + or – 10%.
- Ovens are equipped with cordset and NEMA plug (single phase; 120V or 208-240V, depending on oven model.) It is sufficient to insert the plug in the proper outlet (the outlet must be suitable for the plug assembled on the oven.)

4.2 WATER CONNECTION (available on all current manual models EXCEPT XAF-103 per below)

- **CONNECTION TO THE WATER NET: Full Size manual oven models (XAF-183 & XAF-193)** come with an electrovalve for direct water connection.
 - ◆ A mechanical filter must be placed between the water system and the water connection of the oven.
 - ◆ Before connecting the water pipe to the oven, please allow a suitable amount of water flow, in order to clean the duct from any residue.
 - ◆ The water used in the oven must have a nominal pressure value between 0.5 and 2 bars.
 - ◆ The water must have a hardness between 0.5° and 5°F (to avoid formation of lime deposits inside the electric valve and inside the cavity).
 - ◆ Cadco suggests you use a decalcification filter in order to maintain fan balance.
- **AUXILIARY WATER PUMP (FOR CONNECTION TO AN EXTERNAL WATER TANK:):** **Half Size manual ovens (XAF-113 & XAF-133)** come with an Auxiliary Water Pump included, for manually pumping water from a bucket, water tank, or other container. **WARNING: Before using the water pump, always make sure that there is water in the tank. Damage to the pump can occur if it is operated without water in the tank and it will void your warranty.** If the pump makes “groaning” sounds, it is probably due to lack of water in the tank or the pump is simply running an air bubble through the system.

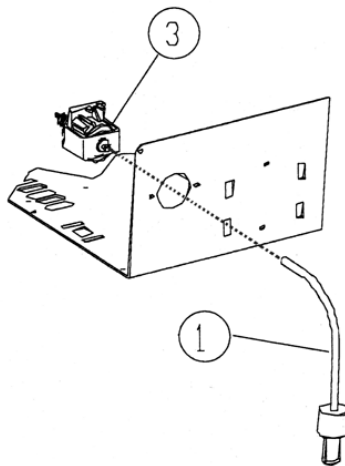

To install:

- 1) Part (1) is found in the plastic bag inside your oven cavity, along with the oven feet.)
- 2) Connect the pipe (1) of the filter to the pump (3) by pushing it onto the nipple of the pump sticking out of the back of the oven, as shown.
- 3) Insert the filter into a water tank (such as Cadco model XC655) or other water container.
- 4) Connect oven to power supply.
- 5) **Use only decalcified water.**

- Hot air and steam will exit the oven from the back exhaust port. During most cooking cycles, you will have hot and humid exhaust coming out from this exhaust port (temperature and humidity of this exhaust depend on the cooking parameters being used.) The steam that comes out of the exhaust port can also be vented outside if desired.

II. INSTRUCTIONS FOR THE USER

Never allow grease splatters or spills to collect on the inside walls, floor, or ceiling of your oven. A simple cleaning with soap and water is usually enough to keep your oven spotless and in “like new” condition for years. Your oven should never be cleaned with a water hose or anything more powerful than a spritz bottle. For tougher cleaning and built up grease, we suggest using Foam Plus® from Discovery Products Corporation (Tel. 877.822.8500.)



1. INSTRUCTIONS FOR THE OPERATOR

You will find important information about maintaining and operating your new oven in this manual. Please read the manual and become familiar with your new oven before you begin to operate it. Keep the manual in a safe place and make sure everyone reads it before operating the oven. Please use only Cadco authorized service centers and always require quality UNOX-OEM parts. Failure to comply with these standards can compromise safety and will void your warranty.

2. NOTES FOR USE

- Your Cadco oven was designed to cook food and must be used only for that specific purpose. Any other use may void your warranty. The oven allows you to work between 175°F and 500°F. It is suggested that you allow about 2-3” between trays for proper air circulation during the cooking process.

Use your Cadco oven for:

- ♦ Baking all types of bread and pastry, both fresh and frozen.
- ♦ Cooking any meat, fish, or fowl.
- ♦ Rethermalizing any cooled or frozen cooked foods.
- ♦ Cooking (not steaming) any kinds of vegetables.
- Please avoid salting your food products while they are inside the cooking cavity. Salt is very corrosive and may, over time, damage the interior of your oven.

3. CONTROL PANEL

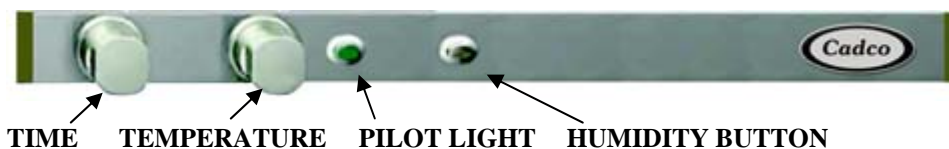

3.1 TIME DIAL

- To operate your oven, you must first turn the time dial clockwise to the time you choose, from 0 to 60 minutes (if you’re facing the oven, it is the dial on the left side of the control panel).
- You may also turn the time dial counterclockwise and click the dial over to operate the oven continuously, until you manually turn the knob back to “0”.
- Whether you have chosen to set an actual time, or have set the time dial for continuous “on”, the internal light will turn on and the fan will begin spinning.

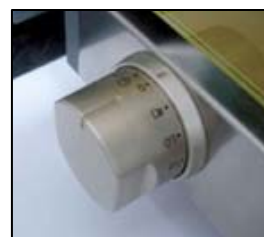

3.2 TEMPERATURE DIAL

- The cooking temperature inside the cooking chamber is set by the temperature knob (if you’re facing the oven, it is the dial on the right side of the control panel).
- Turn the dial clockwise and set your desired temperature. At this time the green pilot light, located just to the right of the temperature dial will turn on. This indicates that the oven is preheating.
- Always preheat oven before placing food into it.
- **Please note:** the green pilot light will fluctuate on and off throughout the cooking cycle. This indicates that the heating element is turning on and off to help keep the actual temperature within 5-10 degrees of the set temperature.



3.3 HUMIDITY (On Models XAF-113, XAF-133, XAF-183, XAF-193)

- These models have a manual humidity injection feature. Pressing the silver humidity button introduces a spritz of water to the cooking cavity, creating a moist cooking environment. The spritzing will continue until the button is released. The humidity indicator light will illuminate when the humidity feature is being used.
- Warning! To keep from damaging the motors, the humidity injection button should only be pressed for short [5-10 seconds] intermittent periods. These ovens are not designed for steaming foods.
- When operating below 300°F, the oven may develop excess water in the cooking cavity if too much water is spritzed into the cavity..
- **WARNING:** Before using the water pump, always make sure that there is water in the tank. Damage to the pump can occur if it is operated without water in the tank and it will void your warranty. If the pump makes “groaning” sounds, it is probably due to lack of water in the tank or the pump is simply running an air bubble through the system.

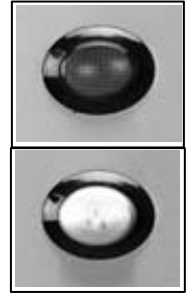

4. DOOR & FANS (FULL SIZE MODELS XAF-183 & XAF-193 ONLY!)

- Fans stop automatically when oven door is opened.
- Convection fans reverse direction approximately every 2 minutes for even baking.

5. CLEANING THE OVEN

- **WARNING: Before starting any maintenance or cleaning operation, it is necessary to disconnect the electrical power supply and wait for your oven to cool down.**

5.1 BEFORE USING THE OVEN FOR FIRST TIME

- ◆ Before plugging oven in:
 - Pull out & clean oven side racks and wire shelves separately (using damp cloth, hot soapy water), then replace when done.
 - Clean oven cavity (using damp cloth, hot soapy water.)
- ◆ With the oven cavity empty, heat the oven for 30 minutes to 350°F (eliminating odors caused by residual protective factory grease.)
- ◆ Never clean the oven cavity with acids, abrasives, or aggressive detergents..

5.2 GENERAL

- ◆ Wipe up any spills as they occur (after the oven has cooled down for 10-15 minutes.)
- ◆ Never clean the oven cavity with acids, abrasives or aggressive detergents.
- ◆ Never use a spray of water to clean the outside of your oven. This may damage the electrical components and void your warranty.



5.3 DAILY CLEANING

- ◆ Unplug oven and let it cool down for 10-15 minutes.
- ◆ Clean the oven cavity and oven door gasket using only proper products (degreaser, damp cloth.) (Never clean the oven cavity with acids, abrasives, or aggressive detergents.)
- ◆ Pull out and clean oven side racks and wire shelves separately, then replace when done.
- ◆ For heavily soiled areas, let degreaser sit to penetrate before wiping with damp cloth or scrub pad.
- ◆ Wipe door handle, door glass (inner and outer), and oven control panel using only proper products (detergent, damp cloth.)
- ◆ Wipe dry after each cleaning process.

5.4 WEEKLY CLEANING

- ◆ Follow protocol for Daily Cleaning.
- ◆ Remove and clean oven door gasket
 - Pull gasket out of the channel.
 - Clean with detergent & water or dishwasher.
 - Dry and let sit.
 - To replace after cleaning, push back into channel around oven door.
- ◆ Clean the outside of the oven using only proper products (degreaser, damp cloth.)
- ◆ Remove the inner door glass & clean (follow separate instructions below.)
- ◆ Never clean the oven with acids, abrasives, or aggressive detergents.
- ◆ Wipe dry after each cleaning process.

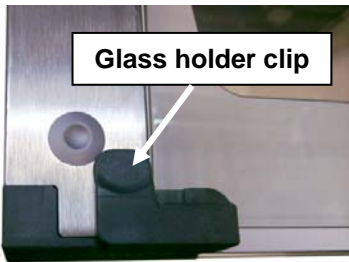
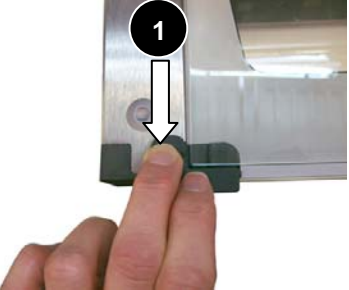
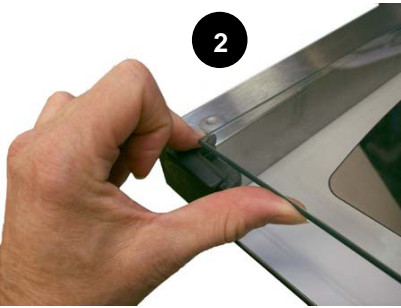
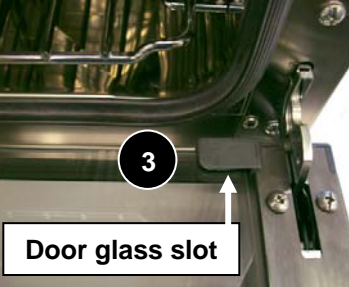
5.4 CLEANING THE OVEN DOOR GLASS

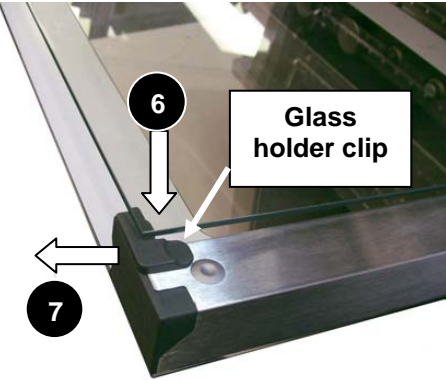
 <p>Glass holder clip</p>	<p>Open oven door and remove inner door glass using the following directions. (Glass holder clips on left & right sides of door keep inner door glass in place.)</p>	 <p>1</p>	<p>1) With oven door open completely, use fingers to pull left and right glass holder clips forward until fully extended and the corner of the door glass is visible.</p>
 <p>2</p>	<p>2) Using fingers to hold glass holder clips open, position thumbs under the inner door glass and push glass up until it just clears the glass holder tabs. Release glass holder clips while supporting the door glass with thumbs.</p>	 <p>3</p> <p>Door glass slot</p>	<p>3) Grasp both sides of the glass firmly and pull the glass toward you until it clears the door glass slots at the bottom of the door. <i>(Be careful to support the glass when pulling it toward you, to avoid the back edge of the glass dropping onto the outer door glass below it.)</i> Lift the glass and place gently on countertop.</p>
<p>4) Clean the door glass, using a soft cloth moderately dampened with soap and water or glass cleaner. Rinse glass and dry it completely.</p>  <p>5</p> <p>YES NO</p> <p>5) Position cleaned inner door glass over the open oven door so that the oval logo on the glass is facing down in the left back corner. Slide the back edge of the door glass into the door glass slots at the bottom of the door.</p>	 <p>6</p> <p>Glass holder clip</p> <p>7</p> <p>6) Lower the glass until it is resting on the glass holder clips.</p> <p>7) Pull the glass holder clips forward until the glass drops into place in the door. Then release the glass holder tabs to hold the glass in place.</p>		

6. TURNING OFF IN CASE OF BREAKDOWN

If you encounter any kind of problem while your oven is in operation, or if you notice anything out of the ordinary, follow these steps:

- ◆ Unplug your oven immediately.
- ◆ Consult Cadco, Ltd. at 877-603-7393 (Toll-Free)

Failure to do so may result in a hazardous condition and void your warranty.

III. COOKING PRINCIPLES

1. COOKING MODES

• CONVECTION COOKING

- ◆ Food products bake in hot, moving air. This moving air removes the cool air barrier between the cool food being cooked, and the heat of the oven chamber. It also helps your food products to cook evenly and quickly. Foods cook faster with convection.

• CONVECTION & HUMIDITY

- ◆ Adding humidity while baking helps many products retain moisture. In some cases, such as with Pate Choux, the product will gain in volume.
- ◆ Moisture also makes the heat seem hotter (similar to a humid day) and products may cook a little faster.

2. COOKING VARIABLES

• TEMPERATURE

- ◆ The exact setting of your oven temperature assures proper cooking of your food, both inside and outside:
 - Too low – your food cooks too slowly and will dry out.
 - Too High – your foods burns and cooks unevenly.
- ◆ If you are new to convection cooking, Cadco suggests setting your Convection Oven to a temperature of about 30°F - 50°F lower than what you would have set it at in a conventional oven. Let the food tell you what it needs; if it browns too fast, turn the oven temperature down.

• TIME

- ◆ The higher the temperature the quicker your foods will get done.
- ◆ The quicker foods (especially protein products) cook, the more moisture they tend to lose.
- ◆ Most bakery products can take high temperatures better than protein products.

• HUMIDITY

- ◆ The more humidity in the cooking cavity, the harder it will be for your food products to brown.

• QUANTITY OF FOOD

- ◆ One piece of chicken will take less time to cook than 2 or 3 pans of chicken. That's "Mother Nature" pure and simple. Convection cooking is fantastic, but it's NOT magic.
- ◆ Overloading the oven can result in uneven cooking.
- ◆ Avoid placing baked goods touching each other on the pan before baking.

3. USE OF WIRE GRIDS AND SHEET PANS

- It is recommended to use wire grids for meat items. This will elevate your food items and allow air to circulate all around during the cooking process. Place your wire rack in a sheet pan to collect the juice. This reduces clean-up time also.
- Use sheet pans for bakery items such as pastries, bread and rolls, and cookies.

IV. MAINTENANCE

1. ORDINARY MAINTENANCE

- All maintenance operations must be done only by trained qualified personnel.
- Before starting any maintenance operation, disconnect your oven from the electrical power supply and







wait for it to cool down.

- The parts that need ordinary maintenance can be reached by removing the front control panel and the back of the oven.

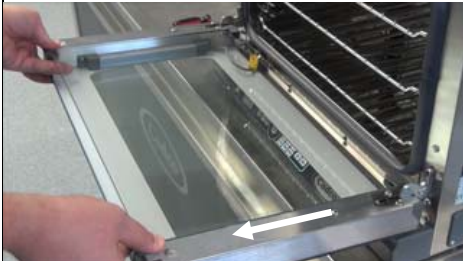
2. SPECIAL MAINTENANCE

- All maintenance operations must be done only by trained qualified personnel.
- Before starting any maintenance operation, disconnect your oven from the electrical power supply and wait for it to cool down.

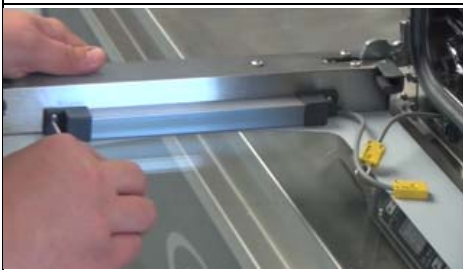
2.1 REPLACEMENT OF DOOR LAMP (WHERE APPLICABLE)

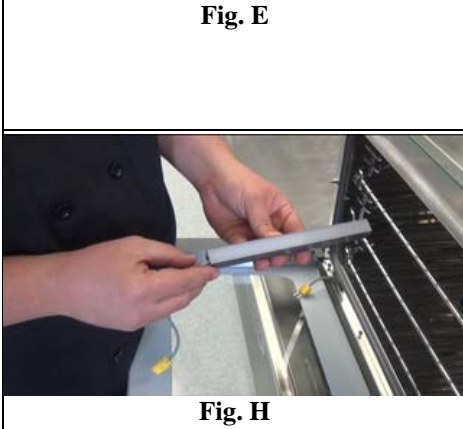
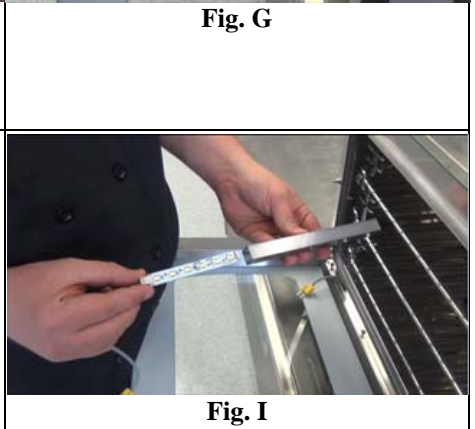
 <p>Fig. A</p>	<p>1) Unplug the oven and allow to cool down completely. 2). Open door completely as in Fig. A. 3) Remove inner door glass by pulling both glass holder clips back (Fig. A) and lifting the glass carefully up and back towards you. Fig. B. 4) Place door glass gently on counter.</p>	 <p>Fig. B</p>
 <p>Fig. C</p>	<p>5) Unplug the yellow door light connector by pulling the two sides apart gently. Figs. C & D.</p>	 <p>Fig. D</p>
 <p>Fig. E</p>	 <p>Fig. F</p>	 <p>Fig. G</p>
 <p>Fig. H</p>	<p>6) With Phillips head screwdriver, unscrew and remove both light cover brackets. Figs. E-F-G.</p> <p>7) Slide the LED light assembly out of the light cover. Figs. H-I.</p>	 <p>Fig. I</p>

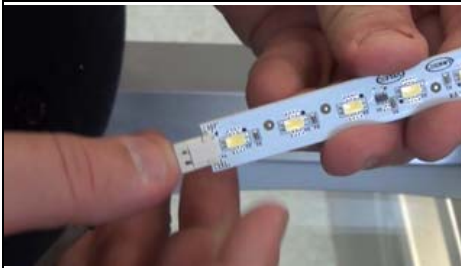

Fig. J
OLD LED light

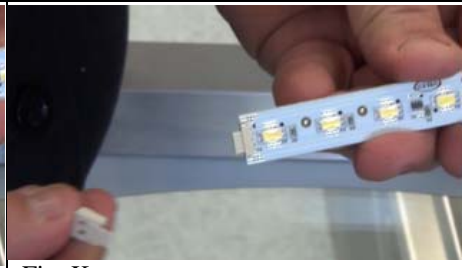

Fig. K
8) Carefully unsnap the LED light assembly from the wire clip, and replace it with the new LED light assembly. Figs. J-K-L.

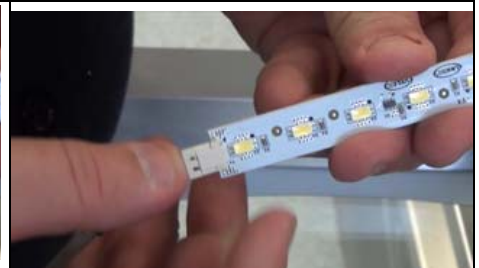

Fig. L
NEW LED light



Fig. M
9) Replace the top cover bracket, but do not fully tighten the screws yet.



Fig. N
10) Slide the LED light assembly fully into the light cover. Figs. N-O.



Fig. O



Fig. P 11) Slide the light cover into the top bracket, making sure the opaque side of the cover is facing up.



Fig. Q
12) With the wire notch facing down, replace the bottom bracket.



Fig. R 13) Attach the bottom cover bracket, making sure the wire is seated in the wire notch.



Fig. S

14) Fully tighten the screws on the top cover bracket. Fig. S

15) Plug the halves of the cord connector together. They only fit one way. Fig. T.



Fig. T

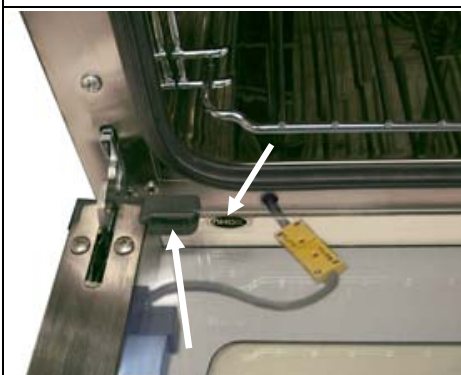

Fig. U

16) Replace the inner door glass by positioning it over the open oven door so that the oval logo on the glass is facing down in the left back corner. **Fig. U.**

Slide the back edge of the door glass into the door glass slots at the bottom of the door. **Fig. U.**

17) Lower the glass until it is resting on the glass holder clips. **Fig. V**

18) Pull the glass holder clips back until the glass drops into place in the door. Then release the glass holder clips to hold the glass in place.

19) Close the oven door.

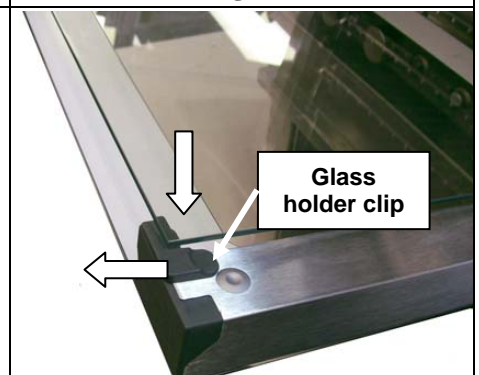
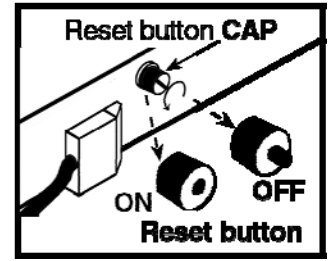

Fig. V

2.2 RESET THE SAFETY THERMOSTAT

- This oven is equipped with a manually resettable safety thermostat designed to protect the oven against overheating. If there is an intervention, it completely deactivates the oven to avoid permanent damage.
- To reset this device, remove the black cap positioned to the bottom of the back of the oven by unscrewing it counterclockwise, push the reset button under the cap, and replace the black cap.
- If the safety thermostat shuts your oven off, before turning your oven back on, be sure to check your entire circuit to verify that the total amps being drawn by all the appliances, lights, etc. on that circuit do not exceed the amps available on that circuit.







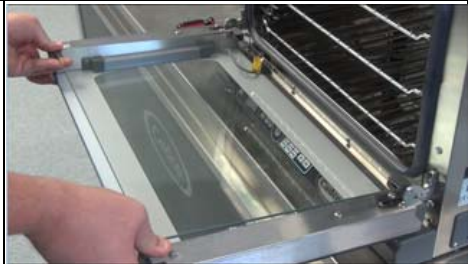

V. OPTIONAL MANUAL CONVECTION OVENS ACCESSORIES

- **OV-HDS Heavy-Duty 2-Oven Stand with Wheels** (half +/- or quarter size size)
 - ◆ Accommodates two half or quarter size Cadco Convection Ovens
- **OST-195 Oven Stand with Wheels** (full size)
 - (Note: Shorter oven feet must be used when placing oven on this stand.)
 - ◆ Accommodates oven models: XAF-183, XAF-188, XAF-193 & XAF-195
- **OST-34 Oven Stand with Wheels** (half size)
 - ◆ Accommodates oven models: XAF-111, XAF-113, XAF-115, XAF-130, XAF-133, XAF-130 & XAF-135
- **Oven Baskets:** Stainless steel oven baskets enhance even airflow around food for quicker, crisper results
 - ◆ **COB-F Oven Basket** (Full Size)
 - ◆ **COB-H Oven Basket** (Half Size)
 - ◆ **COB-Q Oven Basket** (Quarter Size)
- **Pizza Heat Plates** provide very fast baking times, up to 50% faster than traditional baking pans. It takes as little as 4-5 minutes to bake a fresh Pizza on the aluminum heat plate! The plates are manufactured from alloys which provide superior heat storage and produce fast, even cooking of both top and bottom of the food product simultaneously. These plates also help maintain better temperature stability under normal door opening/ closing conditions. Great for pizza, breads & other baked goods.
 - ◆ **CAP-F Pizza Heat Plate** (Full Size)
 - ◆ **CAP-H Pizza Heat Plate** (Half Size)
 - ◆ **CAP-Q Pizza Heat Plate** (Quarter Size)
- **XC605 Air Deflector Plate**
 - ◆ Deflects the strong airflow in oven cavity; for baking delicate foods like puff pastry
 - ◆ Attaches quickly to fan grid; no tools required.
- **Stacking Kits for XAF Half-Size & Full-Size Convection Ovens**
 - ◆ Everything needed to securely stack one XAFT oven on top of another and protect the top oven's control panel from heat rising from bottom:
 - ◆ - 4 Special size oven legs (2-3/4" high) for the top oven
 - ◆ - Brackets
 - ◆ - Heat Baffle (protects top oven's control panel from heat generated by lower oven)
 - ◆ - Bottom oven vent extension
 - ◆ - All needed screws & clamps

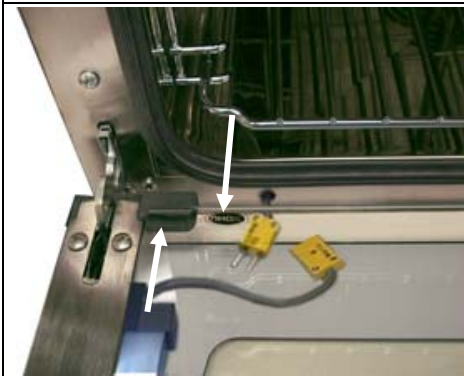
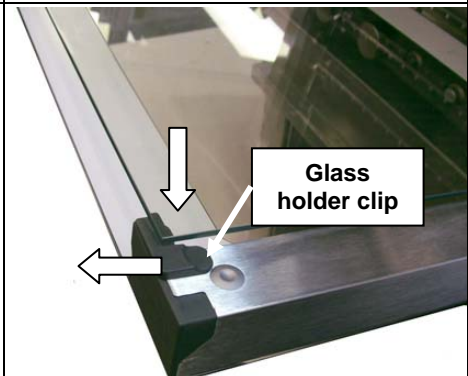

VI. Remove & Reattach The Door

 <p>Fig. A</p>	<p>1) Unplug the oven and allow to cool down completely. 2) Open door completely as in Fig. A. 3) Remove inner door glass by pulling both glass holder clips back (Fig. A) and lifting the glass carefully up and back towards you. Fig. B. 4) Place door glass gently on counter.</p>	 <p>Fig. B</p>
 <p>Fig. C</p>	<p>5) Unplug the yellow door light connector by pulling the two sides apart gently. Figs. C & D.</p>	 <p>Fig. D</p>
 <p>Fig. E</p>	<p>6) Replace the inner door glass by positioning it over the open oven door so that the oval logo on the glass is facing down in the left back corner. Fig. E. Slide the back edge of the door glass into the door glass slots at the bottom of the door. Fig. E. 7) Lower the glass until it is resting on the glass holder clips. Fig. F 8) Pull the glass holder clips back until the glass drops into place in the door. Then release the glass holder clips to hold the glass in place.</p>	 <p>Fig. F</p>
 <p>Fig. G</p>	 <p>Fig. H</p>	 <p>Fig. I</p>
<p>9) Using a screwdriver or other object, swing door safety locks down on both sides as shown in Figs G-H-I.</p>		

Door removal instructions continued on next page.

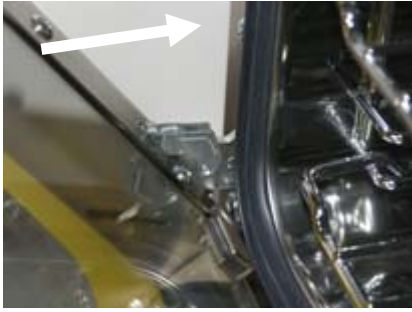

Fig. J

10) With door completely down and door safety lock in its down position, move door in a closing direction until door safety lock stops the closing action as in **Fig. J**.

11) Hold door as shown in **Fig. K**.



Fig. K



Fig. L

12) Slightly lift and swing door out of unit as shown in **Figs. L & M**.



Fig. M

Reverse above procedure to attach door to oven.



Fig. N

NOTE: For the door to be properly reinstalled, the notch on the bottom of the hinge finger (**Fig. N**) must be seated in the inner door hinge frame (**Fig. O**)



Fig. O

VII. COOKING GUIDE

The first and most important step will be: Have your new oven hooked up to the proper power and (if applicable) water source. If there is any doubt about the proper power or the connections, have the oven installed by a qualified electrician according to your local codes.

Use this cooking guide to help determine which time and temperature works best for your specific food items. If your specific product isn't addressed, you will probably find something similar.

You'll find many helpful hints in this cooking guide. Our aim is to help you use your Cadco Manual Convection Oven to its fullest, rather than teach you how to cook.

The Cadco Heavy-Duty Manual Convection Ovens work on the principle of moving air. This air movement removes the "Hot Spots" so we get very even browning, rapid preheats (10 minutes), and faster cooking.

Here are some basic do's and don'ts and guidelines for convection cooking:

- ◆ Use pans that have sides no taller than a common sheet pan.
- ◆ Preheat the oven to approximately 40°-50°F above your baking temperature.
- ◆ **After loading your product, remember to reset the oven to the desired baking temperature.**
- ◆ If you notice uneven cooking, set the oven temperature down 25°-30°F. Let the product tell you if it needs more or less heat.
- ◆ Aluminum foil can get pulled into the fan and cause damage.
- ◆ Don't overload the oven.
- ◆ Maintain a minimum 2"-3" between the product being cooked and the next shelf. Remove shelves if necessary.
- ◆ Your Cadco Convection Oven is a powerful tool, so don't hesitate to utilize its full capacity.
- ◆ Keep your oven clean. Wipe up spills as they occur. Never allow grease to build up on the interior of the oven, or collect on the bottom of the cooking cavity.
- ◆ Frozen products draw more heat from the oven and may require a longer recovery time.
- ◆ When roasting meats we suggest using a cooking rack to elevate the product and facilitate even roasting. Smaller cuts such as boneless chicken breasts, or seafood portions may be baked directly on the pan if desired.
- ◆ Lower temperatures will reduce shrinkage and save money with all of your roasted meat products.
- ◆ Higher geographical elevations will often affect cooking time and temperature parameters.

Have fun and experiment with your new Cadco Convection Oven. Your times and temperatures will vary with the different products you prepare. Refer to this Cadco Cooking Guide for direction or contact the Cadco Culinary Manager (877.603.7393) or the Cadco, Ltd. website (www.cadco-ltd.com), for specific answers to your cooking needs.

We look forward to hearing from you,
Cadco, Ltd.

- **Cookies**

- **Baking Temperature**

One of the most common items baked in your Cadco Convection Oven will be cookies. There are dozens of cookie manufacturers, and their products all have different baking characteristics. Most of the cookie recipes suggest a baking temperature of 325° - 350°F. We have found that “Lower is better”. Over the years we have found that cookies bake best in a preheated oven at about 285° - 300°F, assuming a 1.5 ounce cookie from refrigerated/frozen dough. By baking at a lower temperature, they tend to remain higher after cooling and produce a more eye appealing finished product. Bake for about 12-18 minutes, depending on what you think is the perfect cookie.

- **Variables**

- ♦ Lower the temperature for larger cookies.
- ♦ Cookies bake from the outside in...so to make picture perfect cookies we have to consider two variables before we begin baking, in any oven, or we may not be happy with our results. These two factors come into play mostly when we make cookies from "scratch", (but they apply to all cookies):
 1. **The temperature of the dough**
 - Room temperature dough will spread out more than frozen or refrigerated dough.
 - The colder the dough, the less the cookie will spread / flatten out during baking.
 - Dough baked from frozen produces a thicker, better-looking cookie than ones that are baked from refrigerated, or room temperature, which will spread out and therefore, have less height.
 2. **The fat content of the dough.**
 - A higher ratio of fat to flour will make the cookie spread out more during baking.

- **Cheesecake**

People generally love cheesecake and it's not hard to make. Let's start with a basic cheesecake batter:

- ♦ #3 cream cheese
- ♦ 1 ½ cups sugar
- ♦ 5 eggs
- ♦ lemon to taste
- ♦ 2 cups Half and Half (approx.)

This will make enough batter for a 10” springform pan.

There are so many fun options for making cheesecake, such as:

- ♦ Substitute chocolate milk for Half and Half in a triple chocolate cheesecake.
- ♦ Orange juice for an orange cheesecake.
- ♦ Baileys Irish Cream.
- ♦ Cookie dough.
- ♦ Turtle cheesecake.
- ♦ Lemon poppy seed.
- ♦ Pumpkin...peanut butter...pistachio...what else?

For crust, spray the inside of the springform pan with vegetable oil and dust it with graham cracker crumbs. There are endless options for crusts such as shortbread, brownie, or Ladyfingers, or a simple dusting of graham crumbs. It's your choice.

Bake in a 200°F oven for 4 hours, then cool, cut and serve.

Have fun with some imaginative sauces also:

- ♦ Walnut, caramel and chocolate chip sauce.
- ♦ Lemon sauce.
- ♦ Pear sauce
- ♦ Pistachio sauce.
- ♦ Cinnamon Squared² Sauce (cinnamon stick and candies).

- **Muffins**

- ◆ 15 minutes at 325°F/ 20% humidity works well for most standard size muffins.
- ◆ For jumbo muffins set the oven temp at 300°F/ 20% humidity and bake the muffins for 20 minutes or until a toothpick comes out clean.
- ◆ The more dense your batter is the longer your muffins will take to bake.

- **Biscuits**

For the test we used a basic baking powder biscuit about 3” in diameter. Bake at 350°F for 10-12 minutes.

Some suggestions:

- ◆ A simple glaze can be made of powdered sugar and water.
- ◆ Glaze while your biscuits are still hot.
- ◆ Try peanut butter, lemon poppy seed, cinnamon raisin, cheese and bacon, sour dough, and of course, good old buttermilk biscuits.
- ◆ Drop biscuits take about the same amount of time to bake and they are wonderful.

- **Bread**

- ◆ Large loaves (1 lb -1 ½ lb) baked in 30 - 40 minutes at 325°F.
- ◆ We found that you can bake dinner rolls using the same method as you do for biscuits.

- **Pies**

The variables for bakery products are endless, and pies are no exception. These are some of the things which will affect your cooking time:

- ◆ Amount of sugar in the crust.
- ◆ Size of your pie tin and the amount of filling used.
- ◆ Butter or oil in the crust.
- ◆ Amount of shortening to flour.
- ◆ Your choice of canned or fresh filling.

For test pies we used 9” pie tins with homemade apple filling. Our crust was made using a basic 3-2-1 recipe:

- ◆ 3 parts flour
- ◆ 2 parts shortening
- ◆ 1 part (approx.) water
- ◆ With a little salt and a four finger pinch of sugar added

The Cadco Convection Oven was preheated to 325°F and the pies were baked for 45 minutes to an hour depending on the filling. The aroma coming out of the Cadco Training Center was fantastic!

- **Pizza**

There are so many pizzas it’s hard to know where to start. The pizza we used for our tests were the 11”, frozen, self rising type from the grocery store. They were all baked at 350°F for 8 - 20 minutes on **Cadco Pizza Heat Plates** (see page 8), and our results were great on all of them. (The pizza manufacturers suggested a temperature of 400°F for 20-30 minutes).



- **“Oven Fried” Chicken**

Let’s say that you want to serve fried chicken in your food service operation but you don't want all of the problems associated with a chicken program. You don't want to deal with an expensive breading program, the high insurance costs, constantly buying oil, employee training, the dangerous cleaning/filtering of French fryers, and the high cost of purchasing equipment. Cadco has the answer: how about **"Oven Fried" chicken**. We take cooked, frozen, browned chicken and season it with the seasoning(s) of your choice to produce the most delicious, unique chicken your customers have ever tasted...and it's all done in your oven in about 30 minutes. Your chicken goes from the freezer, to the oven, to the display case (and your customers) in less time than it takes to fry from raw.

We suggest Pierce Super Chicken; lay it out in a Cadco **Oven Fry Basket (Model COB-F/Full Size)**, and season the pieces with any seasoning of your choice. Then you simply bake it in the Cadco Convection Oven at 325°F for 20 minutes and it's ready to serve. You can have Cajun, Lemon Pepper, Italian, TexMex, Smoky, Jamaican, or...Whatever flavor you want, “Oven Fried” Chicken!

- **“Rotisserie Style” Chicken**

Tired of paying the grocery store to make those delicious rotisserie chickens for you? Once you make your own “Rotisserie” chickens, in your Cadco Convection Oven, you’ll never buy another cooked chicken from the store again (and I’ll bet your customers won’t either).

- ◆ You’ll need a baking sheet pan and a cooking rack to keep your chicken elevated during the cooking process. The cooking rack allows air to circulate all around the chicken, similar to a rotisserie. You can also place your chicken directly on the oven rack and let it drip into a pan below.
- ◆ **Caution! Never allow grease to drip onto the bottom of the oven!**

Method

- ◆ Season a #3 chicken and place it on the cooking rack. (For options, see below)
- ◆ Preheat your Convection Oven to 325°F.
- ◆ Roast the chicken for about 45 minutes. If a crispier product is desired, raise the temperature to about 350°F.
- ◆ Cook chicken to an internal temperature of 180°F.
- ◆ Stuffing the chicken will increase cooking time and it is NOT suggested.

Options

- ◆ Slip slices of lemon under the skin on the breast before roasting.
- ◆ Italian sausage under the skin of the breast before roasting.
- ◆ Sun dried tomatoes, fresh herbs, under the skin before roasting.
- ◆ Spray the chicken with olive oil, season, and dust with mashed potato flakes before roasting.
- ◆ Save the chicken fat after roasting and chill it. Mix the fat, and a little stock, with left over shredded chicken, and season with salt and pepper, to make a spread on slices of French bread. Needless to say...this is NOT heart-healthy fare, but it sure is good.
- ◆ Truss the chicken before roasting for more even cooking and eye appeal. Call for my quick method of trussing a bird.

- **Burgers**

- ◆ Lay your ¼ pound frozen burgers out onto a sheet pan and season to taste. Place them into 350°F oven for about 10 to 12 minutes.
- ◆ Hamburger should be cooked to an internal temperature of 165°F to be safe according to HACCP guidelines.
- ◆ Try cooking your burgers at 250°F for 15 to 20 minutes and notice how juicy they are. Browning is not as pronounced using the low temperature method, but the added flavor makes up for it.

- **Rare Roast Beef**

- ◆ Rare beef is considered by most people to be 130°F.
- ◆ The USDA states that full muscle beef when roasted to an internal temperature of 130°F and maintained at that temperature for 121 minutes is considered safe to eat.
- ◆ Overnight roasting requires a roast that is 7 pounds or larger.
- ◆ Seasonings will penetrate the roast about 1/4" deep.
- ◆ Cook elevated on a roasting rack so we have air circulation all around during the roasting process.
- ◆ Cook over a shallow sided pan to collect the pan juices for jus or gravy.

- **Roast Tenderloin (quick roast and serve method) –**

- ◆ Preheat your oven to 400°F
- ◆ Load the tenderloin in the oven and reduce the roasting temperature to 350°F
- ◆ Roast the tenderloin to an internal temperature of 120°F and remove from the oven. The roast will continue to rise in temperature.
- ◆ In about 10 minutes (130°F) the tenderloin will be ready to slice and serve

- **Jus**

- ◆ Use your pan drippings to make jus. Many people say "I'm going to make some au jus". This is incorrect and professionals will notice. Au jus means "with juice". Prime Rib becomes "Prime Rib Au Jus" when you add jus to the plated Prime Rib.
- ◆ Use beef/veal/chicken stock to dissolve all that wonderful tasting brown gooey material in the bottom of your roasting pan. Some add a little red wine, some add tomato, and some make their jus to theme: Cajun, Southwest, Oriental.....you get the idea.

VIII. WARRANTY

- Cadco, Ltd. warrants all products (in the United States and Canada) to be free from defects in material and workmanship for a period of one year from date of purchase, unless otherwise noted below.***
- Warranty does not apply in cases of misuse, abuse or damage from external service or repair attempts by unauthorized personnel.
- **Copy of original invoice is required for proof of purchase date for warranty coverage.**
- **ALL WARRANTY / SERVICE ISSUES MUST BE AUTHORIZED FIRST! PLEASE CALL TOLL-FREE (877) 603-7393.**
- **WARRANTY PERIODS:**
 - ◆ **HEAVY-DUTY MANUAL CONVECTION OVENS:**
 - **All Models:** Two Year Limited Warranty (One year On-site service & parts, 2nd year parts only)***
 - ◆ **ALL OVENS (INCLUDING HEAVY-DUTY MANUAL CONVECTION OVENS):**
 - 90 day warranty on all light bulbs and gaskets. **NOTE:** These items are easily changeable on-site by user and **do not qualify for service center warranty assistance.** Call Cadco directly for warranty replacement of these items.
 - 30 day warranty on glass.
 - **ALL CONVECTION OVEN MOTORS ARE BACKED BY A ONE YEAR WARRANTY**
- **WARRANTY PROCEDURES:**
 - ◆ The customer is responsible to ship or deliver Carry-in service items to a Cadco authorized service center, or directly to Cadco**, along with a copy of the original invoice or sales receipt for proof of purchase date, and a description of the problem.
 - ◆ *****If returning a unit directly to Cadco, Ltd. for warranty repair, please call us first for a Return Authorization Number. Return Authorization Number MUST be written on outside of carton to track the unit and avoid service delays.***
 - ◆ *If shipping the unit to Cadco or to a service location, be sure to pack it securely and insure it for its original purchase price. Cadco is not responsible for damage or loss of unit in transit to us or a service center.
 - ◆ ***Please do not take your unit to the store where you purchased it for warranty repair. For the Cadco authorized US service agent nearest you, please contact:***
Cadco, Ltd., 200 International Way, Winsted, CT 06098
Tel. (860) 738-2500, Fax (860) 738-9772
E-mail: info@cadco-ltd.com, Web site: www.cadco-ltd.com

7/28/2016 RV17